

CONNECTOR SELECTION GUIDE



FOR USE WITH PRODUCTS
MANUFACTURED BY:



This guide lists popular options for Simpson Strong-Tie hangers used with engineered wood products. Not all available hanger and installation combinations are listed. Use in conjunction with the current Simpson Strong-Tie **Wood Construction Connectors** catalog for detailed hanger information.

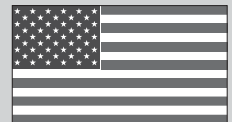

**ALLOWABLE
STRESS DESIGN**

DISTRIBUTED BY:

800-999-5099
www.strongtie.com

CSG-BC12 1/12
exp. 12/15

General Notes

1. See current Wood Construction Connectors catalog for Important Information and General Notes section and for hanger models, joist sizes, and support conditions not shown. See pages 10-11 of this guide for installation information.
2. Loads listed in tables address the attachment of the hanger to a solid support member. Loads listed under the Download heading cover Douglas Fir, Southern Pine and LVL, except for LVL made primarily from Spruce-Pine-Fir or similar low density material, use loads listed under SPF in the current Wood Construction Connectors catalog. Joist or beam reactions should be checked by a qualified designer to ensure proper hanger selection.
3. Uplift loads listed for single and double I-Joists assume DF or similar flanges and have been increased by 60% for earthquake and wind loading with no further increase allowed. Reduce loads according to code for normal duration loading such as cantilever construction.
4. The top flange of an I-joist must be laterally supported to prevent rotation; see Prevent Rotation below.

5. For top flange hangers, configuration and thickness of hanger top flange need to be considered for flush framing conditions, see page 10.
6. For this publication, support members are assumed to be at least 5½" tall. The horizontal thickness of the support member must be at least the length of the nail being used and at least the length of the hanger top flange.
Exception: face mount hangers may be mounted on support members narrower than the nail length provided the nail penetration is at least 1¼ inches for 10d or 2 inches for 16d; nails are clinched.
7. THAI hangers in shown in the single and double I-joist tables are based on the "top flange" installation and require that the carrying member have a horizontal thickness of at least 2½". THAI hangers are not rated for uplift.
8. All nails shown are common nails unless otherwise noted.

I-Joist Headers

When supporting one I-joist from another, backer blocks must be used. Backer blocks are to be made from plywood, OSB, or dimension lumber. The thickness of a backer block should be the same thickness as the void in the side of the I-joist and a minimum of 12" wide. Attach with 10-10d common nails clinched as necessary, prior to installing the hanger. For Top Flange hangers, install backer blocks tight to top flange. For Face Mount hangers, install backer blocks tight to bottom flange. Refer to I-Joist manufacturer literature for specific guidelines.

Sloped Joists:

For joists sloped up to ¼:12, there is no reduction of load. For slopes greater than ¼:12, see table.

Sloped Joist		
Model	Slope	Reduction
ITS, IUS, MIT, MIU, LBV, BA, HB	½:12 max	10%
WP, HW, WPU	¾:12 max	15%

Top Flange Hangers:

Use 10dx1½" nails for all Top Flange hangers attached to an I-joist header. See table for allowable loads.

Model No.	I-Joist Header: 1½" Thick Flange Material ¹	
	DF/SCL	SPF
ITS	1085	940
MIT	1230	885
LBV	1495	1350
BA	1495	1495

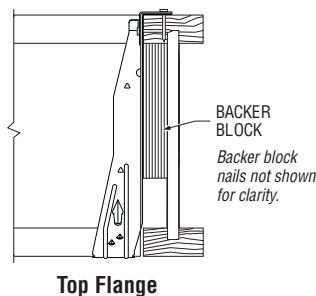

1. For flanges with thicknesses from 1½" to 1¾", use 0.85 of the I-joist header load. For flanges with thicknesses from 1¾" to 2", use 0.75 of the I-joist header load.

Face Mount Hangers:

Nails that get less than 2 inches of penetration must be clinched on the back side. Double I-joist headers must be attached together to act as a single unit.

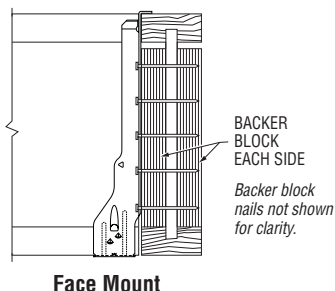

Prevent Rotation

Hangers provide some joist rotation resistance; however, additional lateral restraint may be required for deep joists.

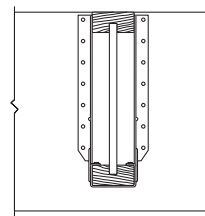

No Web Stiffener Req'd
when hanger side flanges laterally restrain joist top flange to prevent rotation.

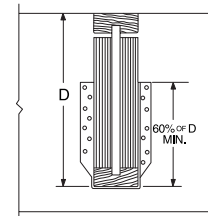

Web Stiffener Required
Hanger side flange should be at least 60% of joist depth or potential joist rotation must be addressed.

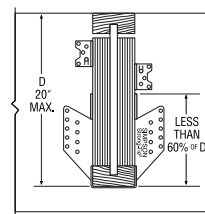

Rotation Resistance
If non-skewed hanger side flange is less than 60% of joist depth, attach staggered A34 framing anchors above the hanger.

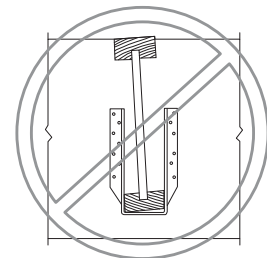

No Rotation Resistance
Lack of web stiffeners combined with short hanger does not laterally support the top flange.

HOW TO PICK A HANGER

Follow these simple steps to choose your hanger:
(For I-joist headers, see page 2)

1	Find your joist size in this guide. (Single I-joist, Double I-joist, Beam)
2	Locate your connector type in the table. <ul style="list-style-type: none">• Face mount, top flange, skewed, sloped, etc.
3	Select a hanger from the table.
4	Confirm that your joist load is less than the hanger allowable load.
5	Check to see if the bearing length “B dim” meets the bearing length requirement of the I-joist manufacturer. If yes, you have successfully selected your hanger.
	If you did not find a suitable hanger; Please see the current <i>Wood Construction Connectors</i> catalog or call Simpson Strong-Tie at (800) 999-5099. You will need the following information: <ul style="list-style-type: none">• Download• Uplift• Header condition• Bearing length requirement

SINGLE I-JOISTS – U.S./Allowable Load (lbs)



Joist Height	Top Flange						Face Mount						45° Skew					
	Model	B Dim	Fastener Type		Uplift (160)	Down Load (100)	Model	B Dim	Fastener Type		Uplift (160)	Down Load (100)	Model	B Dim	Fastener Type		Uplift (160)	Down Load (100)
			Header	Joist					Header	Joist					Header	Joist		
BCI 4500 (EASTERN U.S.)																		
Joist Width = 1 1/4"																		
9 1/2	ITS1.81/9.5	2	6-10d	—	105	1520	IUS1.81/9.5	2	8-10d	—	75	950	SUR/L1.81/9	3	12-16d	2-10dx1 1/2	155	1730
11 7/8	ITS1.81/11.88	2	6-10d	—	105	1520	IUS1.81/11.88	2	10-10d	—	75	1185	SUR/L1.81/11	3	16-16d	2-10dx1 1/2	155	2305
14	ITS1.81/14	2	6-10d	—	105	1520	IUS1.81/14	2	12-10d	—	75	1420	SUR/L1.81/14	3	20-16d	2-10dx1 1/2	155	2500
16	ITS1.81/16	2	6-10d	—	105	1520	IUS1.81/16	2	14-10d	—	75	1660	SUR/L1.81/14	3	20-16d	2-10dx1 1/2	155	2500
BCI 5000²																		
Joist Width = 2"																		
9 1/2	ITS2.06/9.5	2	6-10d	—	105	1520	IUS2.06/9.5	2	8-10d	—	75	950	SUR/L2.06/9	3 3/16	14-16d	2-10dx1 1/2	195	2015
11 7/8	ITS2.06/11.88	2	6-10d	—	105	1520	IUS2.06/11.88	2	10-10d	—	75	1185	SUR/L2.06/11	3 3/16	16-16d	2-10dx1 1/2	195	2305
14	ITS2.06/14	2	6-10d	—	105	1520	IUS2.06/14	2	12-10d	—	75	1420	SUR/L2.06/14	3 3/16	18-16d	2-10dx1 1/2	195	2590
16	ITS2.06/16	2	6-10d	—	105	1520	IUS2.06/16	2	14-10d	—	75	1660	SUR/L2.06/14	3 3/16	18-16d	2-10dx1 1/2	195	2590
BCI 60/6000²																		
Joist Width = 2 3/16"																		
9 1/2	ITS2.37/9.5	2	6-10d	—	105	1520	IUS2.37/9.5	2	8-10d	—	75	950	SUR/L2.37/9	3 3/16	14-16d	2-10dx1 1/2	195	2015
11 7/8	ITS2.37/11.88	2	6-10d	—	105	1520	IUS2.37/11.88	2	10-10d	—	75	1185	SUR/L2.37/11	3 3/16	16-16d	2-10dx1 1/2	195	2305
14	ITS2.37/14	2	6-10d	—	105	1520	IUS2.37/14	2	12-10d	—	75	1420	SUR/L2.37/14	3 3/16	18-16d	2-10dx1 1/2	195	2590
16	ITS2.37/16	2	6-10d	—	105	1520	IUS2.37/16	2	14-10d	—	75	1660	SUR/L2.37/14	3 3/16	18-16d	2-10dx1 1/2	195	2590
BCI 6500²																		
Joist Width = 2 3/16"																		
9 1/2	ITS2.56/9.5	2	6-10d	—	105	1520	IUS2.56/9.5	2	8-10d	—	75	950	SUR/L2.56/9	3 3/16	14-16d	2-10dx1 1/2	225	2015
11 7/8	ITS2.56/11.88	2	6-10d	—	105	1520	IUS2.56/11.88	2	10-10d	—	75	1185	SUR/L2.56/11	3 3/16	16-16d	2-10dx1 1/2	225	2305
14	ITS2.56/14	2	6-10d	—	105	1520	IUS2.56/14	2	12-10d	—	75	1420	SUR/L2.56/14	3 3/16	18-16d	2-10dx1 1/2	225	2590
16	ITS2.56/16	2	6-10d	—	105	1520	IUS2.56/16	2	14-10d	—	75	1660	SUR/L2.56/14	3 3/16	18-16d	2-10dx1 1/2	225	2590
BCI 90																		
Joist Width = 3 1/2"																		
11 7/8	ITS3.56/11.88	2	6-10d	—	105	1425	IUS3.56/11.88	2	12-10d	—	75	1420	SUR/L410	2 5/8	14-16d	6-16d	1300	2015
14	ITS3.56/14	2	6-10d	—	105	1425	IUS3.56/14	2	12-10d	—	75	1420	SUR/L414	2 5/8	18-16d	8-16d	1765	2500
16	ITS3.56/16	2	6-10d	—	105	1425	IUS3.56/16	2	14-10d	—	75	1425	SUR/L414	2 5/8	18-16d	8-16d	1765	2500
18	MIT418	2 1/2	8-16d	2-10dx1 1/2	215	2305	MIU3.56/18	2 1/2	26-16d	2-10dx1 1/2	210	3745	SUR/L414	2 5/8	18-16d	8-16d	1765	2500
20	MIT420	2 1/2	8-16d	2-10dx1 1/2	215	2305	MIU3.56/20	2 1/2	28-16d	2-10dx1 1/2	210	4030	SUR/L414	2 5/8	18-16d	8-16d	1765	2500

1. Shaded hangers require web stiffeners at joist ends. Web stiffeners may also be required by the manufacturer for non-shaded hangers.
2. At the maximum capacity shown, hangers may exceed the standard 1/8" deflection by 1/32".
3. Some joist are not available in every height shown. Check with manufacturer for availability.

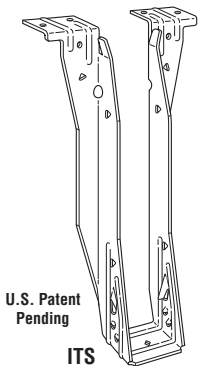

ITS – 18 gauge
The ITS top flange hanger with its Strong-Grip™ seat and Funnel Flange™ installs faster than any other top flange hanger. Joist nails are not required.

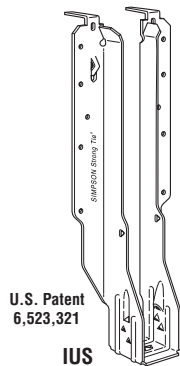

IUS – 18 gauge
The IUS is a hybrid hanger that incorporates the advantages of face-mount and top-flange hangers. Joist nails are not required.

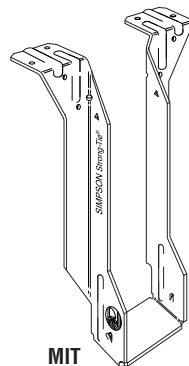

MIT – 16 gauge
The MIT's Positive Angle Nailing helps minimize splitting of the I-joists' bottom flange. Features uplift capacity and extended seat design (to allow installation of slightly undercut joists).

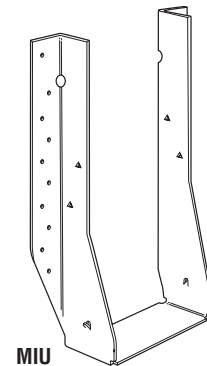

MIU – 16 gauge
The MIU series features 16 gauge steel and extra nailing for higher loads than the IUT.

SINGLE I-JOISTS – U.S./Allowable Load (lbs)

Joist Height	Adjustable Height							Field Slope & Skew					
	Model	B Dim	Fastener Type			Uplift (160)	Down Load (100)	Model	B Dim	Fastener Type		Uplift (160)	Down Load (100)
			Header		Joist					Header	Joist		
			Top	Face									
BCI 4500 (EASTERN U.S.)													
Joist Width = 1 1/4"													
9 1/2	THAI1.81/22	2 1/4	4-10d	2-10d	2-10dx1 1/2	—	1715	LSSUI25	3 1/2	9-10d	7-10dx1 1/2	785	995
11 7/8	THAI1.81/22	2 1/4	4-10d	2-10d	2-10dx1 1/2	—	1715	LSSUI25	3 1/2	9-10d	7-10dx1 1/2	785	995
14	THAI1.81/22	2 1/4	4-10d	2-10d	2-10dx1 1/2	—	1715	LSSUI25	3 1/2	9-10d	7-10dx1 1/2	785	995
16	See Wood Construction Connectors catalog for hanger selection						See Wood Construction Connectors catalog for hanger selection						
BCI 5000²													
Joist Width = 2"													
9 1/2	THAI2.06/22	2 1/4	4-10d	2-10d	2-10dx1 1/2	—	1715	LSSUI2.06	3 1/2	9-10d	7-10dx1 1/2	785	995
11 7/8	THAI2.06/22	2 1/4	4-10d	2-10d	2-10dx1 1/2	—	1715	LSSUI2.06	3 1/2	9-10d	7-10dx1 1/2	785	995
14	THAI2.06/22	2 1/4	4-10d	2-10d	2-10dx1 1/2	—	1715	LSSUI2.06	3 1/2	9-10d	7-10dx1 1/2	785	995
16	See Wood Construction Connectors catalog for hanger selection						See Wood Construction Connectors catalog for hanger selection						
BCI 60/6000²													
Joist Width = 2 3/8"													
9 1/2	THAI3522	2 1/4	4-10d	2-10d	2-10dx1 1/2	—	1715	LSSUI35	3 1/2	9-10d	7-10dx1 1/2	785	995
11 7/8	THAI3522	2 1/4	4-10d	2-10d	2-10dx1 1/2	—	1715	LSSUI35	3 1/2	9-10d	7-10dx1 1/2	785	995
14	THAI3522	2 1/4	4-10d	2-10d	2-10dx1 1/2	—	1715	LSSUI35	3 1/2	9-10d	7-10dx1 1/2	785	995
16	See Wood Construction Connectors catalog for hanger selection.						See Wood Construction Connectors catalog for hanger selection.						
BCI 6500²													
Joist Width = 2 3/8"													
9 1/2	THAI322	2 1/4	4-10d	2-10d	2-10dx1 1/2	—	1715	LSSUH310	3 1/2	14-16d	12-10dx1 1/2	1150	1600
11 7/8	THAI322	2 1/4	4-10d	2-10d	2-10dx1 1/2	—	1715	LSSUH310	3 1/2	14-16d	12-10dx1 1/2	1150	1600
14	THAI322	2 1/4	4-10d	2-10d	2-10dx1 1/2	—	1715	LSSUH310	3 1/2	14-16d	12-10dx1 1/2	1150	1600
16	See Wood Construction Connectors catalog for hanger selection.						See Wood Construction Connectors catalog for hanger selection.						
BCI 90													
Joist Width = 3 1/2"													
11 7/8	THAI422	2 1/4	4-10d	2-10d	2-10dx1 1/2	—	1715	LSSU410	3 1/2	14-16d	12-10dx1 1/2	1150	1625
14	THAI422	2 1/4	4-10d	2-10d	2-10dx1 1/2	—	1715	LSSU410	3 1/2	14-16d	12-10dx1 1/2	1150	1625
16	See Wood Construction Connectors catalog for hanger selection						See Wood Construction Connectors catalog for hanger selection						
18													
20													

1. See notes on page 4.

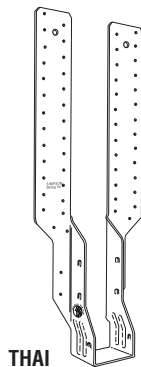

THAI – 18 gauge
This hanger has extra long straps and can be field-formed to give height adjustability and top flange hanger convenience. Positive angle nailing helps minimize splitting of the I-joist's bottom flange. Minimum nailing is shown in the table above. Strap must be field-formed over the top of the header by a minimum of 2 1/2". Web stiffeners required when used with I-joists.

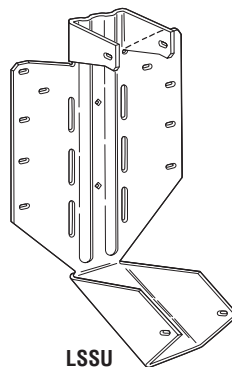

LSSU, LSSUI – 18 gauge
LSSU210-2, LSSU410, and LSSUH310 – 16 gauge
LSU – 14 gauge
LSSU models provide uplift capacity and can be field sloped and/or skewed to 45°. Web stiffeners required when used with I-joists; cut web stiffener to match angle on sloped conditions.

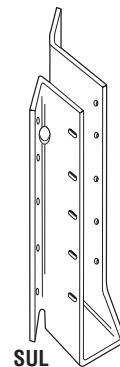

SUR/L – 16 gauge
HSUR/L – 14 gauge
All models are skewed 45°. Normally accommodates a 40° - 50° skew. The installation of these hangers does not require a beveled end cut.

DOUBLE I-JOISTS – U.S./Allowable Load (lbs)



Joist Height	Top Flange						Face Mount						45° Skew					
	Model	B Dim	Fastener Type		Uplift (160)	Down Load (100)	Model	B Dim	Fastener Type		Uplift (160)	Down Load (100)	Model	B Dim	Fastener Type		Uplift (160)	Down Load (100)
			Header	Joist					Header	Joist					Header	Joist		
BCI 4500 (EASTERN U.S.)																		
Joist Width = 3½"																		
9½	MIT49.5	2½	8-16d	2-10dx1½	215	2305	MIU3.56/9	2½	16-16d	2-10dx1½	210	2305	SUR/L410	2½	14-16d	6-16d	1300	2015
11½	MIT411.88	2½	8-16d	2-10dx1½	215	2305	MIU3.56/11	2½	20-16d	2-10dx1½	210	2880	SUR/L410	2½	14-16d	6-16d	1300	2015
14	MIT414	2½	8-16d	2-10dx1½	215	2305	MIU3.56/14	2½	22-16d	2-10dx1½	210	3170	SUR/L414	2½	18-16d	8-16d	1765	2500
16	MIT416	2½	8-16d	2-10dx1½	215	2305	MIU3.56/16	2½	24-16d	2-10dx1½	210	3455	SUR/L414	2½	18-16d	8-16d	1765	2500
Double BCI 5000²																		
Joist Width = 4"																		
9½	MIT4.12/9.5	2½	8-16d	2-10dx1½	215	2305	MIU4.12/9	2½	16-16d	2-10dx1½	210	2305	HSUR/L4.12/9	3	12-16d	2-10dx1½	165	1785
11½	MIT4.12/11.88	2½	8-16d	2-10dx1½	215	2305	MIU4.12/11	2½	20-16d	2-10dx1½	210	2880	HSUR/L4.12/11	3	16-16d	2-10dx1½	165	2380
14	MIT4.12/14	2½	8-16d	2-10dx1½	215	2305	MIU4.12/14	2½	22-16d	2-10dx1½	210	3170	HSUR/L4.12/14	3	20-16d	2-10dx1½	165	2975
16	LBV4.12/16	2½	10-16d	2-10dx1½	265	2460	MIU4.12/16	2½	24-16d	2-10dx1½	210	3455	HSUR/L4.12/16	3	24-16d	2-10dx1½	165	3330
Double BCI 60																		
Joist Width = 4½"																		
11½	MIT3511.88-2	2½	8-16d	2-10dx1½	215	2305	MIU4.75/11	2½	20-16d	2-10dx1½	210	2880	HSUR/L4.75/11	2¾	16-16d	2-10dx1½	165	2380
14	MIT3514-2	2½	8-16d	2-10dx1½	215	2305	MIU4.75/14	2½	22-16d	2-10dx1½	210	3170	HSUR/L4.75/14	2¾	20-16d	2-10dx1½	165	2975
16	MIT4.75/16	2½	8-16d	2-10dx1½	215	2305	MIU4.75/16	2½	24-16d	2-10dx1½	210	3455	HSUR/L4.75/16	2¾	24-16d	2-10dx1½	165	3330
Double BCI 6000²																		
Joist Width = 4½"																		
9½	MIT359.5-2	2½	8-16d	2-10dx1½	215	2305	MIU4.75/9	2½	16-16d	2-10dx1½	210	2305	HSUR/L4.75/9	2¾	12-16d	2-10dx1½	165	1785
11½	MIT3511.88-2	2½	8-16d	2-10dx1½	215	2305	MIU4.75/11	2½	20-16d	2-10dx1½	210	2880	HSUR/L4.75/11	2¾	16-16d	2-10dx1½	165	2380
14	MIT3514-2	2½	8-16d	2-10dx1½	215	2305	MIU4.75/14	2½	22-16d	2-10dx1½	210	3170	HSUR/L4.75/14	2¾	20-16d	2-10dx1½	165	2975
16	MIT4.75/16	2½	8-16d	2-10dx1½	215	2305	MIU4.75/16	2½	24-16d	2-10dx1½	210	3455	HSUR/L4.75/16	2¾	24-16d	2-10dx1½	165	3330
Double BCI 6500²																		
Joist Width = 5¼"																		
9½	MIT39.5-2	2½	8-16d	2-10dx1½	215	2305	MIU5.12/9	2½	16-16d	2-10dx1½	210	2305	HSUR/L5.12/9	2 ¹⁹ / ₁₆	12-16d	2-10dx1½	165	1785
11½	MIT311.88-2	2½	8-16d	2-10dx1½	215	2305	MIU5.12/11	2½	20-16d	2-10dx1½	210	2880	HSUR/L5.12/11	2 ¹⁹ / ₁₆	16-16d	2-10dx1½	165	2380
14	MIT314-2	2½	8-16d	2-10dx1½	215	2305	MIU5.12/14	2½	22-16d	2-10dx1½	210	3170	HSUR/L5.12/14	2 ¹⁹ / ₁₆	20-16d	2-10dx1½	165	2975
16	MIT5.12/16	2½	8-16d	2-10dx1½	215	2305	MIU5.12/16	2½	24-16d	2-10dx1½	210	3455	HSUR/L5.12/16	2 ¹⁹ / ₁₆	24-16d	2-10dx1½	165	3330
Double BCI 90																		
Joist Width = 7"																		
11½	B7.12/11.88	2½	14-16d	6-16d	1010	3800	HU412-2	2½	22-16d	8-16d	1795	3275	HU412-2x³	2½	22-16d	8-16d	1345	2620
14	B7.12/14	2½	14-16d	6-16d	1010	3800	HU414-2	2½	26-16d	12-16d	2695	3870	HU414-2x³	2½	26-16d	12-16d	2020	3095
16	B7.12/16	2½	14-16d	6-16d	1010	3800	HU414-2	2½	26-16d	12-16d	2695	3870	HU414-2x³	2½	26-16d	12-16d	2020	3095
18	B7.12/18	2½	14-16d	6-16d	1010	3800	HU414-2	2½	26-16d	12-16d	2695	3870						
20	B7.12/20	2½	14-16d	6-16d	1010	3800	See Wood Construction Connectors catalog for hanger selection					See Wood Construction Connectors catalog for hanger selection						

1. Shaded hangers require web stiffeners at joist ends. Web stiffeners may also be required for non-shaded areas by the joist manufacturer.
2. At the maximum capacity shown, hangers may exceed the standard 1/8" deflection by 1/32".
3. Skewed option must be special ordered. Specify skew angle and direction (e.g. HU414-2X R45°).
4. LSU's are not field skewable. (Field-slope only.) Skewed option must be special ordered, specify skew angle.
5. THAI-2 must be special ordered. Specify width between 3 1/8" and 5 1/8".
6. Some joist are not available in every height shown. Check with manufacturer for availability.

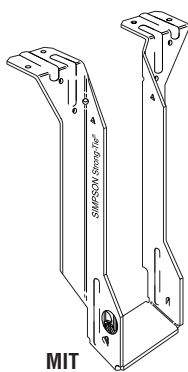

MIT

MIT – 16 gauge
The MIT's Positive Angle Nailing helps minimize splitting of the I-joists' bottom flange. Features uplift capacity and extended seat design (to allow installation of slightly undercut joists).

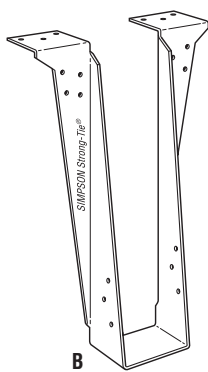

B

B – 12 gauge
The B series offers versatility for I-joists and SCL lumber. Enhanced load capacity widens the range of applications for these hangers.

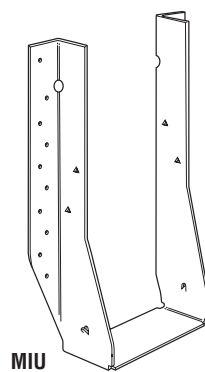

MIU

MIU – 16 gauge
The MIU series features 16 gauge steel and extra nailing for higher loads than the IUT.

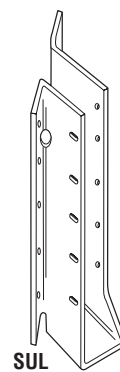

SUR/L

SUR/L – 16 gauge
HSUR/L – 14 gauge
All models are skewed 45°. Normally accommodates a 40°- 50° skew. The installation of these hangers does not require a beveled end cut.

DOUBLE I-JOISTS – U.S./Allowable Load (lbs)

Joist Height	Adjustable Height							Field Slope & Skew						
	Model	B Dim	Fastener Type				Uplift (160)	Down Load (100)	Model	B Dim	Fastener Type		Uplift (160)	Down Load (100)
			Header		Joist	Header					Joist			
			Top	Face										
BCI 4500 (EASTERN U.S.)							Joist Width = 3 1/2"							
9 1/2	THAI422	2 1/4	4-10d	2-10d	2-10dx1 1/2	—	1715	LSSU410	3 1/2	14-16d	12-10dx1 1/2	1150	1625	
11 7/8	THAI422	2 1/4	4-10d	2-10d	2-10dx1 1/2	—	1715	LSSU410	3 1/2	14-16d	12-10dx1 1/2	1150	1625	
14	THAI422	2 1/4	4-10d	2-10d	2-10dx1 1/2	—	1715	LSSU410	3 1/2	14-16d	12-10dx1 1/2	1150	1625	
16	See Wood Construction Connectors catalog for hanger selection.							See Wood Construction Connectors catalog for hanger selection.						
Double BCI 5000							Joist Width = 4"							
9 1/2	THAI-2 ^s	2 1/2	4-10d	2-10d	2-10dx1 1/2	—	2020	LSU4.12 ^s	3 1/2	24-16d	16-10dx1 1/2	1150	2300	
11 7/8	THAI-2 ^s	2 1/2	4-10d	2-10d	2-10dx1 1/2	—	2020	LSU4.12 ^s	3 1/2	24-16d	16-10dx1 1/2	1150	2300	
14	THAI-2 ^s	2 1/2	4-10d	2-10d	2-10dx1 1/2	—	2020	LSU4.12 ^s	3 1/2	24-16d	16-10dx1 1/2	1150	2300	
16	See Wood Construction Connectors catalog for hanger selection.							See Wood Construction Connectors catalog for hanger selection.						
Double BCI 60/6000							Joist Width = 4 3/4"							
9 1/2	THAI-2 ^s	2 1/2	4-10d	2-10d	2-10dx1 1/2	—	2020	LSU3510-2 ^s	3 1/2	24-16d	16-10dx1 1/2	1150	2300	
11 7/8	THAI-2 ^s	2 1/2	4-10d	2-10d	2-10dx1 1/2	—	2020	LSU3510-2 ^s	3 1/2	24-16d	16-10dx1 1/2	1150	2300	
14	THAI-2 ^s	2 1/2	4-10d	2-10d	2-10dx1 1/2	—	2020	LSU3510-2 ^s	3 1/2	24-16d	16-10dx1 1/2	1150	2300	
16	See Wood Construction Connectors catalog for hanger selection.							See Wood Construction Connectors catalog for hanger selection.						
Double BCI 6500							Joist Width = 5 1/4"							
9 1/2	THAI-2 ^s	2 1/2	4-10d	2-10d	2-10dx1 1/2	—	2020	LSU5.12 ^s	3 1/2	24-16d	16-10dx1 1/2	885	1790	
11 7/8	THAI-2 ^s	2 1/2	4-10d	2-10d	2-10dx1 1/2	—	2020	LSU5.12 ^s	3 1/2	24-16d	16-10dx1 1/2	885	1790	
14	THAI-2 ^s	2 1/2	4-10d	2-10d	2-10dx1 1/2	—	2020	LSU5.12 ^s	3 1/2	24-16d	16-10dx1 1/2	885	1790	
16	See Wood Construction Connectors catalog for hanger selection.							See Wood Construction Connectors catalog for hanger selection.						
Double BCI 90							Joist Width = 7"							
11 7/8	See Wood Construction Connectors catalog for hanger selection							See Wood Construction Connectors catalog for hanger selection						
14														
16														
18														
20														

1. See notes on page 6.

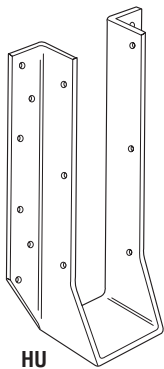

HU

HU – 14 gauge
The HU series features uplift capacity and a large selection of sizes and load ranges. HU hangers have triangle holes that can be filled for increased loads. Web stiffeners required when used with I-joists.

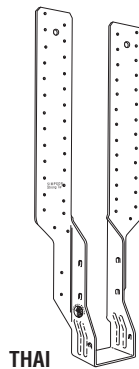

THAI

THAI – 18 gauge
THAI-2 – 14 gauge
This hanger has extra long straps and can be field-formed to give height adjustability and top flange hanger convenience. Positive angle nailing helps minimize splitting of the I-joist's bottom flange. Minimum nailing is shown in the table above. Strap must be field-formed over the top of the header by a minimum of 2 1/2". Web stiffeners required when used with I-joists.

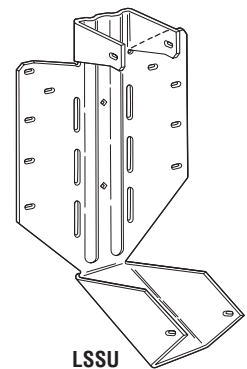

LSSU

LSSU/LSSUI – 18 gauge
LSSU210-2, LSSU410 – 16 gauge
LSU – 14 gauge
LSSU models provide uplift capacity and can be field sloped and/or skewed to 45°. Web stiffeners required when used with I-joists.

LVL BEAMS and HEADERS – U.S./Allowable Load (lbs)



Joist Height	Top Flange						Face Mount					
	Model	B Dim	Fastener Type		Uplift (160)	Down Load ² (100)	Model	B Dim	Fastener Type		Uplift (160)	Down Load (100)
			Header	Joist					Header	Joist		
1 3/4" VERSA-LAM® LVL												
7 1/4	LBV1.81/7.25	3	10-16d	2-10dx1 1/2	265	2910	HU7	2 1/2	16-16d	8-10dx1 1/2	1515	2380
9 1/4	LBV1.81/9.25	3	10-16d	2-10dx1 1/2	265	2910	HU7	2 1/2	16-16d	8-10dx1 1/2	1515	2380
	WPU1.81/9.25	4	7-16d	6-10dx1 1/2	775	4700	HUS1.81/10	3	30-16d	10-16d	3000	5135
9 1/2	MIT9.5	2 1/2	8-16d	2-10dx1 1/2	215	2550	HU9	2 1/2	24-16d	10-10dx1 1/2	1895	3570
	LBV1.81/9.5	3	10-16d	2-10dx1 1/2	265	2910	HUS1.81/10	3	30-16d	10-16d	3000	5135
11 1/4	LBV1.81/11.25	3	10-16d	2-10dx1 1/2	265	2910	HU11	2 1/2	30-16d	10-10dx1 1/2	1895	4465
	WPU1.81/11.25	4	7-16d	6-10dx1 1/2	775	4700	HUS1.81/10	3	30-16d	10-16d	3000	5135
11 7/8	MIT11.88	2 1/2	8-16d	2-10dx1 1/2	215	2550	HU11	2 1/2	30-16d	10-10dx1 1/2	1895	4465
	BA1.81/11.88	3	16-16d	8-10dx1 1/2	1170	4715	HUS1.81/10	3	30-16d	10-16d	3000	5135
14	MIT1.81/14	2 1/2	8-16d	2-10dx1 1/2	215	2550	HU14	2 1/2	36-16d	14-10dx1 1/2	2015	5055
	LBV1.81/14	3	10-16d	2-10dx1 1/2	265	2910	HUS1.81/10	3	30-16d	10-16d	3000	5135
2 Ply 1 3/4" VERSA-LAM® LVL or 3 1/2" VERSA-LAM® LVL												
7 1/4	WPU3.56/7.25	3	7-16d	6-10dx1 1/2	775	4700	HHUS48	3	22-16d	8-16d	2000	4210
9 1/4	LBV3.56/9.25	2 1/2	10-16d	2-10dx1 1/2	265	2910	HHUS410	3	30-16d	10-16d	3735	5635
	HB3.56/9.25	3 1/2	22-16d	10-16d	2610	5815	HGUS410	4	46-16d	16-16d	4095	9100
9 1/2	LBV3.56/9.5	2 1/2	10-16d	2-10dx1 1/2	265	2910	HHUS410	3	30-16d	10-16d	3735	5635
	HB3.56/9.5	3 1/2	22-16d	10-16d	2610	5815	HGUS410	4	46-16d	16-16d	4095	9100
11 1/4	B3.56/11.25	2 1/2	14-16d	6-16d	1010	4135	HHUS410	3	30-16d	10-16d	3735	5635
	HB3.56/11.25	3 1/2	22-16d	10-16d	2610	5815	HGUS412	4	56-16d	20-16d	5045	9600
11 7/8	BA3.56/11.88	3	16-16d	8-10dx1 1/2	1170	4715	HHUS410	3	30-16d	10-16d	3735	5635
	HB3.56/11.88	3 1/2	22-16d	10-16d	2610	5815	HGUS412	4	56-16d	20-16d	5045	9600
14	BA3.56/14	3	16-16d	8-10dx1 1/2	1170	4715	HHUS410	3	30-16d	10-16d	3735	5635
	GTLV3.514	5	10-16d	6-16d	1640	7500	HGUS414	4	66-16d	22-16d	5515	10100
16	BA3.56/16	3	16-16d	8-10dx1 1/2	1170	4715	HHUS410	3	30-16d	10-16d	3735	5635
	GTLV3.516	5	10-16d	6-16d	1640	7500	HGUS414	4	66-16d	22-16d	5515	10100
18	HB3.56/18	3 1/2	22-16d	10-16d	2610	5815	HHUS410	3	30-16d	10-16d	3735	5635
	HGLTV3.518	6	18-16d	6-16d	1640	10500	HGUS414	4	66-16d	22-16d	5515	10100

- HU hangers use both round and triangle holes.
- Download assumes LVL header.
- When ordering the EGQ, HGU, HHGU specify height.

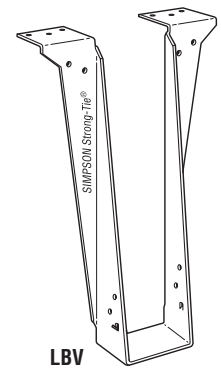
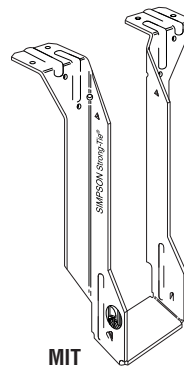
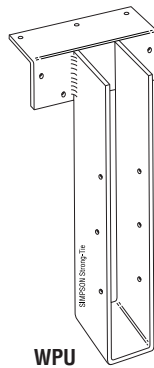
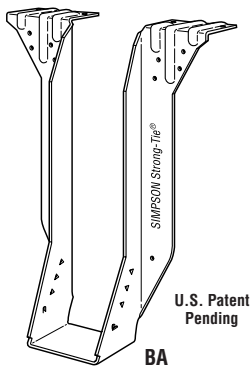

BA – 14 gauge
The BA series offers versatility for I-joists and SCL lumber. Enhanced load capacity widens the range of applications for these hangers.

W, WI – Top flange – 12 gauge;
Stirrup – 12 gauge
WP, WPI, WPU – Top flange – 7 gauge;
Stirrup – 12 gauge
HWU – Top flange – 3 gauge; Stirrup – 10 gauge
This welded series offers the greatest design flexibility and versatility, and a large selection of sizes. Suitable for welded and nailer applications, and modifications including slopes and skews.

MIT – 16 gauge
The MIT's Positive Angle Nailing helps minimize splitting of the I-joists' bottom flange. Features uplift capacity and extended seat design (to allow installation of slightly undercut joists).

LBV – 14 gauge
The LBV is designed especially for use with multiple ply headers 1 1/2" to 1 3/4" thick, and may be used for weld-on applications.

LVL BEAMS and HEADERS – U.S./Allowable Load (lbs)



Joist Height	Top Flange						Face Mount					
	Model	B Dim	Fastener Type		Uplift (160)	Down Load ² (100)	Model	B Dim	Fastener Type		Uplift (160)	Down Load (100)
			Header	Joist					Header	Joist		
3 Ply 1 1/4" VERSA-LAM® LVL or 5 1/4" VERSA-LAM® LVL												
7 1/4	WPU5.50/7.25	3	7-16d	6-10dx1 1/2	775	4700	HU68	2 1/2	14-16d	6-16d	1345	2085
9 1/4	HB5.50/9.25	3 1/2	22-16d	10-16d	2610	5815	HHUS5.50/10	3	30-16d	10-16d	3735	5635
	GLTV5.50/9.25	5	10-16d	6-16d	1640	7500	HGUS5.50/10	4	46-16d	16-16d	4095	9100
9 1/2	HB5.50/9.5	3 1/2	22-16d	10-16d	2610	5815	HHUS5.50/10	3	30-16d	10-16d	3735	5635
	GLTV5.59	5	10-16d	6-16d	1640	7500	HGUS5.50/10	4	46-16d	16-16d	4095	9100
11 1/4	HB5.50/11.25	3 1/2	22-16d	10-16d	2610	5815	HHUS5.50/10	3	30-16d	10-16d	3735	5635
	GLTV5.50/11.25	5	10-16d	6-16d	1640	7500	HGUS5.50/12	4	56-16d	20-16d	5045	9600
11 7/8	HB5.50/11.88	3 1/2	22-16d	10-16d	2610	5815	HHUS5.50/10	3	30-16d	10-16d	3735	5635
	HGLTV5.511	6	18-16d	6-16d	1640	10500	HGUS5.50/12	4	56-16d	20-16d	5045	9600
14	HB5.50/14	3 1/2	22-16d	10-16d	2610	5815	HHUS5.50/10	3	30-16d	10-16d	3735	5635
	EGQ5.50-SDS ³	6	28-SDS 1/4x3	12-SDS 1/4x3	6395	19800	HGUS5.50/14	4	66-16d	22-16d	5515	10100
16	HB5.50/16	3 1/2	22-16d	10-16d	2610	5815	HGUS5.50/14	4	66-16d	22-16d	5515	10100
	EGQ5.50-SDS ³	6	28-SDS 1/4x3	12-SDS 1/4x3	6365	19800	HGU5.50-SDS ³	5 1/4	36-SDS 1/4x2 1/2	24-SDS 1/4x2 1/2	9895	14145
18	HGLTV5.518	6	18-16d	6-16d	1640	10500	HGUS5.50/14	4	66-16d	22-16d	5515	10100
	EGQ5.50-SDS ³	6	28-SDS 1/4x3	12-SDS 1/4x3	6365	19800	HGU5.50-SDS ³	5 1/4	36-SDS 1/4x2 1/2	24-SDS 1/4x2 1/2	9895	14145
4 Ply 1 1/4" VERSA-LAM® LVL or 7" VERSA-LAM® LVL												
9 1/4	HB7.12/9.25	3 1/2	22-16d	10-16d	2610	5815	HHUS7.25/10	3 3/16	30-16d	10-16d	3735	5635
	GLTV49.25-2	5	10-16d	6-16d	1640	7500	HGUS7.25/10	4	46-16d	16-16d	4095	9100
9 1/2	HB7.12/9.5	3 1/2	22-16d	10-16d	2610	5815	HHUS7.25/10	3 3/16	30-16d	10-16d	3735	5635
	GLTV49.5-2	5	10-16d	6-16d	1640	7500	HGUS7.25/10	4	46-16d	16-16d	4095	9100
11 1/4	HB7.12/11.25	3 1/2	22-16d	10-16d	2610	5815	HHUS7.25/10	3 3/16	30-16d	10-16d	3735	5635
	HGLTV411.25-2	6	18-16d	6-16d	1640	10500	HGUS7.25/12	4	56-16d	20-16d	5045	9600
11 7/8	HB7.12/11.88	3 1/2	22-16d	10-16d	2610	5815	HHUS7.25/10	3 3/16	30-16d	10-16d	3735	5635
	EGQ7.25-SDS ³	6	28-SDS 1/4x3	12-SDS 1/4x3	6365	19800	HGUS7.25/12	4	56-16d	20-16d	5045	9600
14	GLTV414-2	5	10-16d	6-16d	1640	7500	HGUS7.25/14	4	66-16d	22-16d	5515	10100
	EGQ7.25-SDS ³	6	28-SDS 1/4x3	12-SDS 1/4x3	6365	19800	HGU7.25-SDS ³	5 1/4	36-SDS 1/4x2 1/2	24-SDS 1/4x2 1/2	9895	14145
16	HGLTV416-2	6	18-16d	6-16d	1640	10500	HGUS7.25/14	4	66-16d	22-16d	5515	10100
	EGQ7.25-SDS ³	6	28-SDS 1/4x3	12-SDS 1/4x3	6365	19800	HHGU7.25-SDS ³	5 1/4	44-SDS 1/4x2 1/2	28-SDS 1/4x2 1/2	14550	17845
18	HGLTV418-2	6	18-16d	6-16d	1640	10500	HGUS7.25/14	4	66-16d	22-16d	5515	10100
	EGQ7.25-SDS ³	6	28-SDS 1/4x3	12-SDS 1/4x3	6365	19800	HHGU7.25-SDS ³	5 1/4	44-SDS 1/4x2 1/2	28-SDS 1/4x2 1/2	14550	17845

1. See notes on page 8.

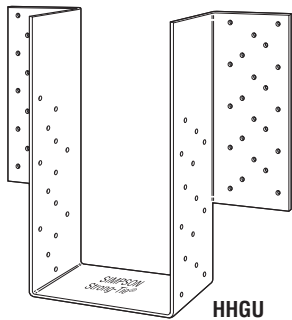

HHGU

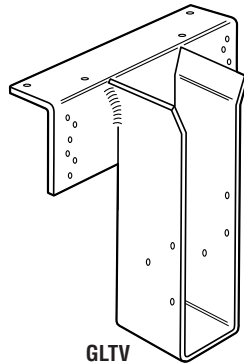

GLTV

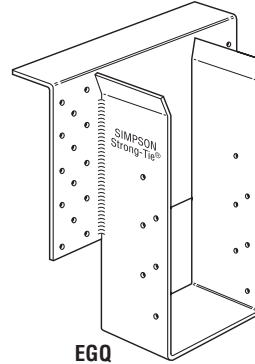

EGQ

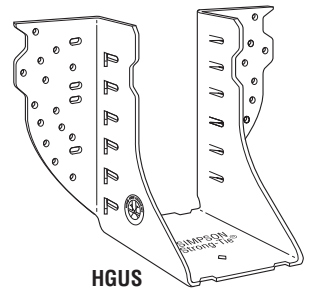

HGUS

HGU – 7 gauge
HHGU – 3 gauge
 The GU hangers are a high-capacity girder hanger designed for situations where the header and joist are flush at top.

GLTV & HGLTV –
 Top flange – 3 gauge
 Stirrup – 7 gauge
 This welded series provides high load carrying capacity and design flexibility and versatility. May be sloped, skewed and modified in other ways, and may be welded to steel I-beams. The GLTV may be used on 4x nailers.

EGQ – Top flange – 3 gauge
 Stirrup – 7 gauge
 A high capacity top flange connector designed for use with Structural Composite Lumber beams.

HGUS – 12 gauge
HHUS – 14 gauge
 Features double shear nailing for high strength and lowest installed cost due to the reduced nail quantity requirement. Not suitable for use with I-joists.

GENERAL CONNECTOR INSTALLATION



Top Flange Hangers

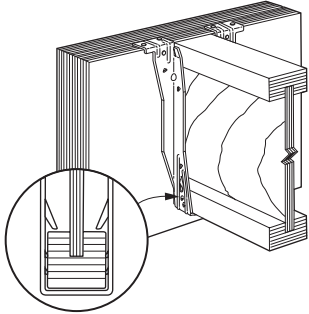

Flush Framing
Top flange configuration and thickness of top flange need to be considered for flush frame conditions.

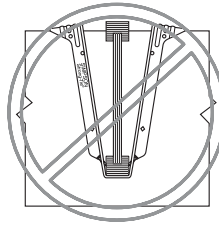

Hanger Over-Spread
If the hanger is over-spread, it can raise the I-Joist above the header and may cause uneven surfaces and squeaky floors.

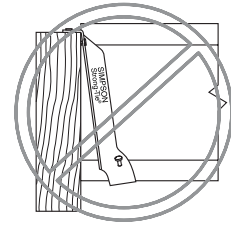

Hanger Not Plumb
A hanger "kicked out" from the header can cause uneven surfaces and squeaky floors.

Wood Nailers

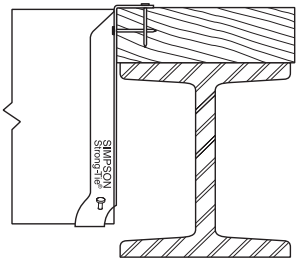

Correct Attachment

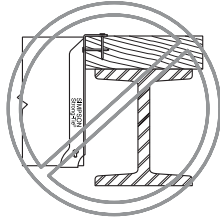

Nailer Too Wide
The loading may cause cross-grain bending. As a general rule, the maximum allowable overhang is $\frac{1}{4}$ ", depending on nailer thickness.

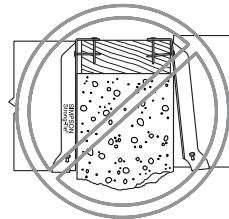

Nailer Too Narrow
Nailer should be full width.

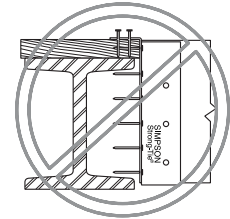

Nailer Too Thin and the wrong hanger for a nailer application.

Nail Hole Shapes

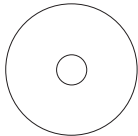

Round Holes
All holes must be filled except for the THAI adjustable height hanger. Refer to load tables for THAI nail quantities.

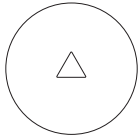

Triangle Holes
Provided on some products in addition to round holes. Round and triangle holes must be filled to achieve the published maximum load value.

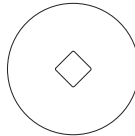

Diamond Holes
Optional holes to temporarily secure connectors to the member during installation.

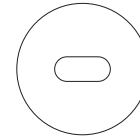

Obround Holes
Used to provide easier nailing access in tight locations. All holes must be filled except for the LSSU hanger when skewed. Refer to load tables for LSSU nail quantities.

Toe Nailed I-Joist

Toe nailing causes squeaks and improper hanger installations. **Do not toe nail I-joists prior to installing either top flange or face mount hangers.**

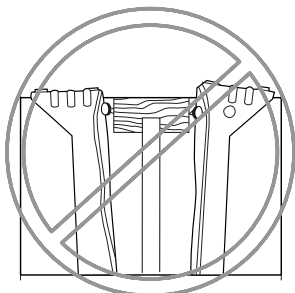

Double Shear Nailing

The nail is installed into joist and header, distributing load through two points on each nail for greater strength.

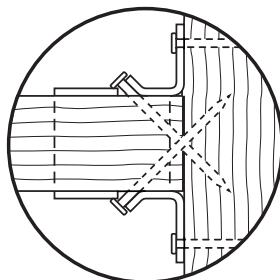

THAI Minimum Nailing

MINIMUM OF $\frac{2}{8}$ " OF TOP FLANGE MATERIAL FOR MINIMUM NAILING CONFIGURATION

Do not nail within $\frac{1}{4}$ " of multiple ply seam.

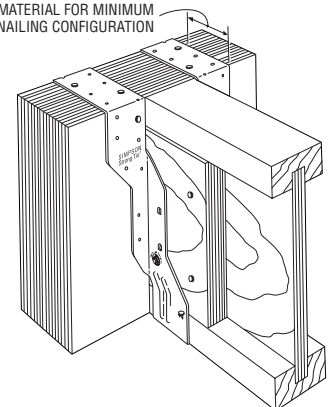

GENERAL CONNECTOR INSTALLATION

ITS Installation Sequence (IUS Similar)

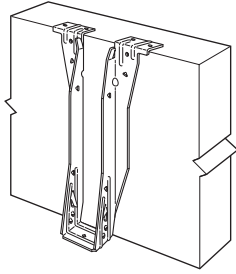

STEP 1
Attach the ITS to the header

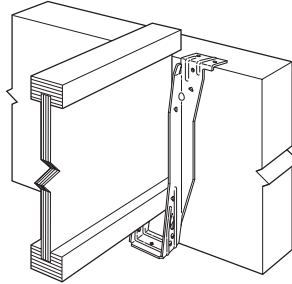

STEP 2
Slide the joist downward into the ITS until it rests above the Strong-Grip™ seat.

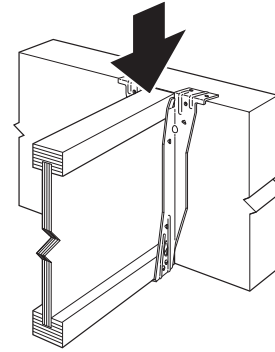

STEP 3
Firmly push or snap joist fully into the seat of the ITS.

LSSU Installation

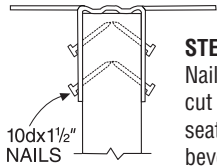

STEP 1
Nail hanger to slope-cut joist, installing seat nail first. No level necessary for skewed installation.

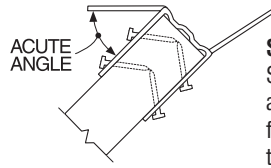

STEP 2
Skew flange to form acute angle. Bend other flange back. Bend along the centerline of slots. Bend one time only.

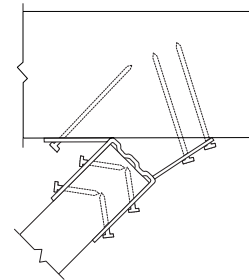

STEP 3
Attach hanger to header, acute angle first. Install nails at an angle.

VPA Installation

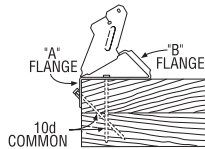

STEP 1
Install top nails and face PAN nails in "A" flange to outside wall top plate.

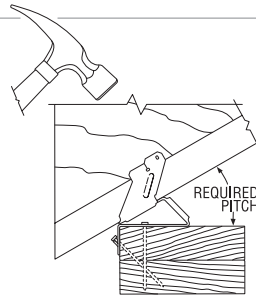

STEP 2
Seat rafter with a hammer, adjusting "B" flange to the required pitch.

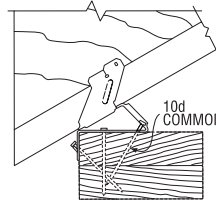

STEP 3
Install "B" flange nails in the obround nail holes, locking the pitch.

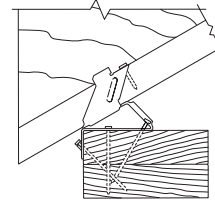

STEP 4
Bend tab with hammer and install nail into tab nail hole. Hammer nail in at approx. 45° angle to limit splitting.

TB - Tension Bridging

Joist Height	Joist Spacing (Inches)								
	12	16	19.2	24	30	32	36	42	48
9½	TB20	TB27	TB27	TB30	TB36	TB36	TB42	TB48	TB54
11⅞	TB20	TB27	TB27	TB30	TB36	TB36	TB42	TB48	TB54
14	TB27	TB27	TB27	TB36	TB36	TB42	TB42	TB48	TB54
16	TB27	TB27	TB30	TB36	TB42	TB42	TB42	TB48	TB54

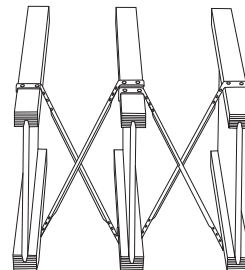

For all bridging avoid contact between steel members (this may cause squeaks).

Typical TB Installation

VPA - Variable Pitch Connectors

Joist Width	Model No.	Fasteners		Allowable Loads							
		Top Plate	Rafter	Uplift (160)		Lateral Load (160)					
				DF/SP	SPF	DF/SP	SPF	DF/SP		SPF	
1¾	VPA25	8-10d	2-10dx1½	295	250	1050	870	375	250	325	250
2	VPA2.06	9-10d	2-10dx1½	295	250	1230	1020	375	250	325	250
2¼ - 2⅝	VPA35	9-10d	2-10dx1½	295	250	1230	1020	375	250	325	250
2½ - 2⅞	VPA3	9-10d	2-10dx1½	295	250	1230	1020	375	250	325	250
3½	VPA4	11-10d	2-10dx1½	295	250	1230	1020	375	250	325	250

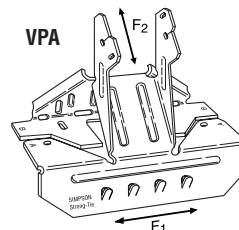

1. VPA's are not appropriate for applications that require more than 2" of bearing, such as intermediate supports.

VPA - 18 gauge
This variable pitch connector allows a sloped beam to sit on a top plate without having to notch, birdmouth, bevel, or toe nail. It also provides uplift capacity. Adjustable from 3:12 to 12:12 pitch.

GENERAL CONNECTOR INSTALLATION



SDW Strong-Drive® Structural Wood Screws

INSTALLATION

- SDW screws install best with a low-speed ½" drill and a T-40 6-lobe bit. The matched bit included with the screws is recommended for best results.
- Screw heads that are countersunk flush to the wood surface are acceptable if the screw has not spun out.
- Individual screw locations may be adjusted up to 3" to avoid conflicts with other hardware or to avoid lumber defects.
- Pre-drilling is typically not required.

Screw Dimensions

Model No.	Nominal Screw Length (L) (in)	Thread Length (TL) (in)	Head Stamp Length
SDW22338	3¾	1⅞	3.37
SDW22500	5	1⅞	5.00
SDW22634	6¾	1⅞	6.75

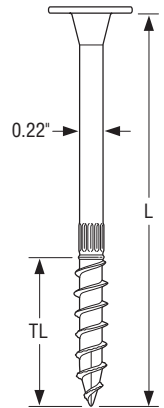
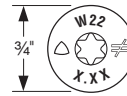

U.S. Patents
5,897,280;
7,101,133 and
patent pending

SDW Strong-Drive®
Screw

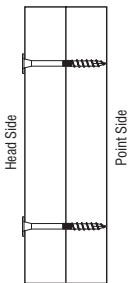

Assembly A-W
(2) - 1¼

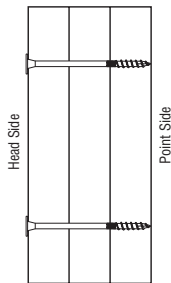

Assembly B-W
(3) - 1¼

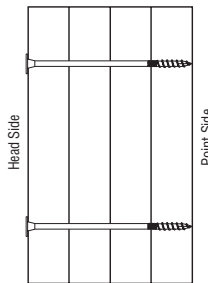

Assembly C-W
(4) - 1¼

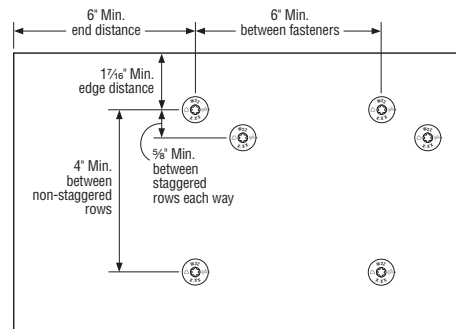

Spacing Requirements

Sideloaded 1¾ Multi-Ply SCL Assemblies – Allowable Uniform Load Applied to Either Outside Member

Multiple Members		Nominal Screw Length (in)	Loaded Side	Structural Composite Lumber					
				SDW @ 12" o.c.		SDW @ 16" o.c.		SDW @ 24" o.c.	
Assembly	Components			2 Rows	3 Rows	2 Rows	3 Rows	2 Rows	3 Rows
A-W	2-ply SCL	3¾	Either	1600	2400	1200	1800	800	1200
B-W	3-ply SCL	5	Head	1200	1800	900	1350	600	900
			Point	900	1350	675	1015	450	675
C-W	4-ply SCL	6¾	Head	1065	1600	800	1200	535	800
			Point	800	1200	600	900	400	600

1. Each ply is assumed to carry same proportion of load.
2. Loads may be applied to the head side and point side concurrently provided neither published allowable load is exceeded. (Example: a 3-ply assembly with a head side load of 1300 plf and point side load of 1000 plf may be fastened together with 3 rows of SDW @ 16" o.c.)
3. When hangers are installed on point side, hanger face fasteners must be a minimum of 3" long.
4. This table assumes an equivalent Specific Gravity of 0.50 or higher.
5. Loads in this table are based on the overall capacity of the Simpson Strong-Tie® SDW22 fasteners. The capacity of the multi-ply assembly must be checked by a qualified Designer.

Refer to the current *Wood Construction Connectors* catalog for General Notes, Warranty Information and other important information, including Terms and Conditions of Sale, Building Code Evaluation listings and Corrosion Resistance.

© 2012 Simpson Strong-Tie Company Inc. • P.O. Box 10789, Pleasanton, CA 94588

CSG-BC12 1/12 exp. 12/15

800-999-5099
www.strongtie.com